

Learn to weave on the
Brooklyn Four Shaft Loom



ashford
WHEELS & LOOMS

spinning | weaving | carding | felting | knitting | dyeing

Welcome to the wonderful world of weaving ...

You are starting an exciting journey of discovery and we know you will enjoy all the texture and colour, creativity and satisfaction that weaving will bring.

In addition to the Brooklyn Four Shaft Loom we make a range of folding table looms. The four shaft loom has a 60cm (24") weaving width and the eight shaft looms are available in 40, 60 or 80cm (16, 24 or 32") weaving widths. The compact eight shaft Katie Loom has a 30cm (12") weaving width. There is also a sixteen shaft table loom with a 60cm (24") weaving width.

This booklet shows our easy warping method and gives instructions for a first project. The same method can be applied to all our table looms.

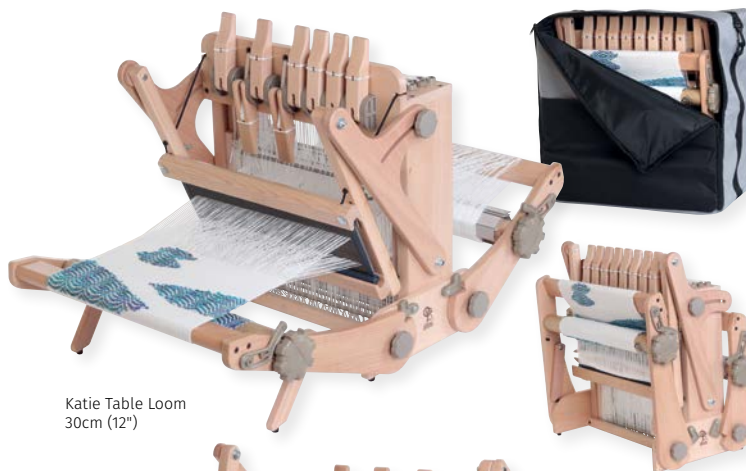

Katie Table Loom
30cm (12")



Folding Eight Shaft Loom 40cm (16")



Folding Four Shaft Loom 60cm (24")
pictured with optional stand



Folding Sixteen Shaft Loom 60cm (24")

Assembly Instructions - Brooklyn Four Shaft Loom 40cm (16")

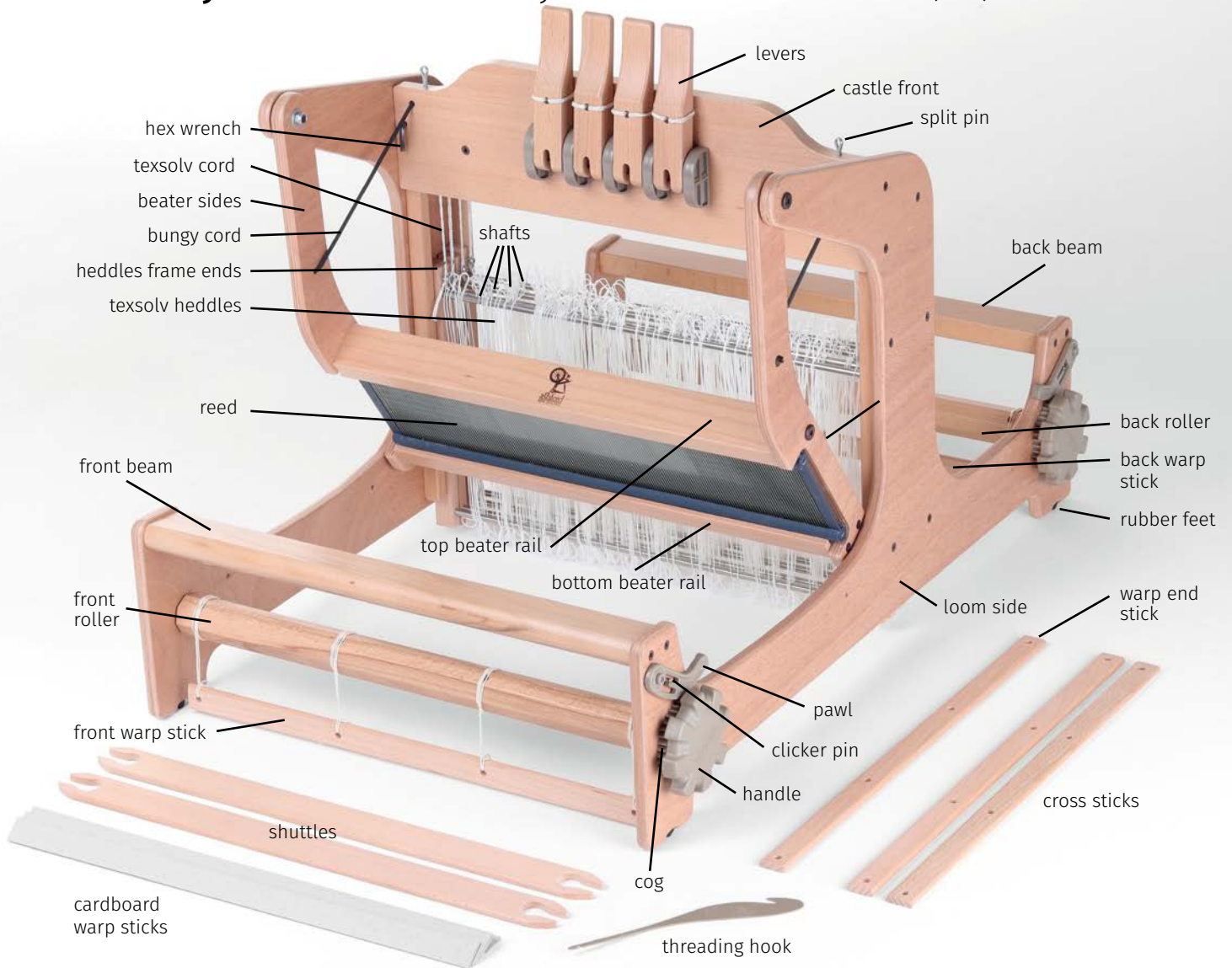

Tools Required



Before Commencing - please read the instructions completely, identify the parts and note the assembly sequence. The Brooklyn Four Shaft Loom is natural unfinished timber. Use the sandpaper supplied to smooth any rough edges. We recommend using Ashford Finishing Wax Polish to protect and seal the wooden loom parts before assembly.

01



Attach the 4 rubber feet to the bottom of the loom sides with 12mm (1/2") screws. To make assembly easier use candle wax on the screws.

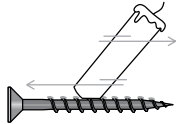

02



Attach each of the 4 shaft guides to the inside of both loom sides with 25mm (1") screws.

03



Remove and discard the wooden protector blocks on the clicker pins. Attach the 2 pawls to the right-hand loom side with 20mm (3/4") machine screws. **Note** the clicker pins fit into the gap in the pawl. Take care to ensure the clicker pins do not damage your table or work bench. Do not over tighten. **Leave a 0.5mm (1/32") gap** under the head of the bolt. The pawl should move freely.

04



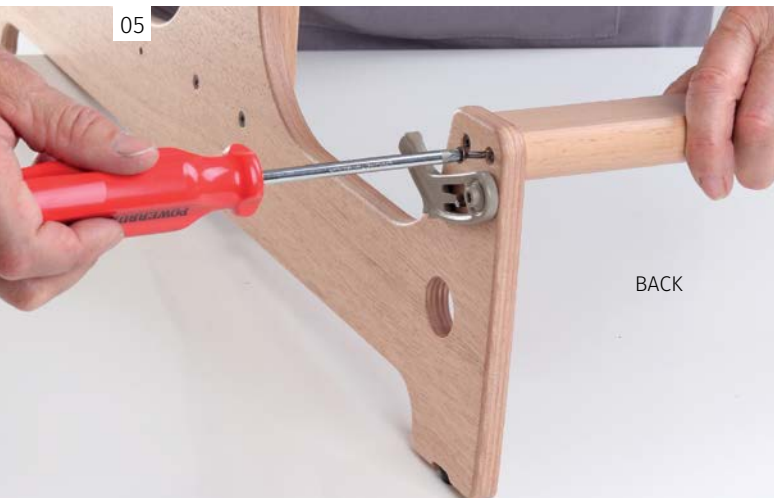

05 With the rounded edge facing outwards attach the front and back beams, to the right-hand loom side with 38mm (1½") screws.

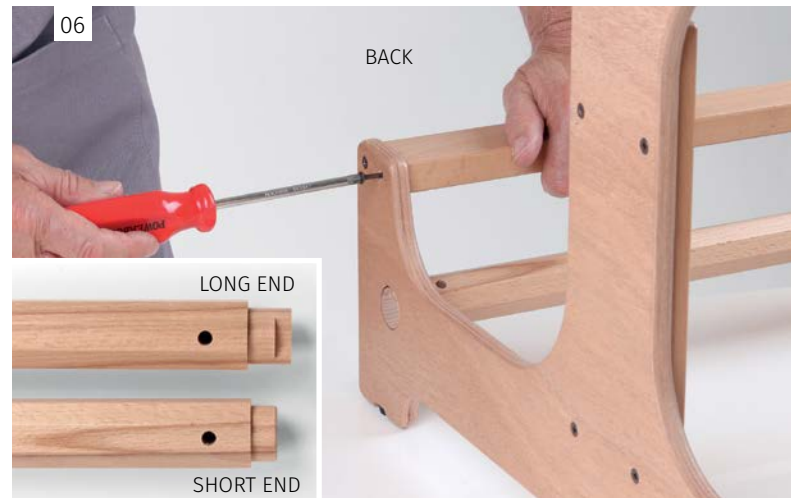

06 Rub a little candle wax on both ends of the rollers. Insert the long ends of the rollers into the holes in the right-hand loom side which has the pawls already attached. Insert the short end of the rollers into the holes in the left-hand loom side and secure to the front and back beams with 38mm (1½") screws.

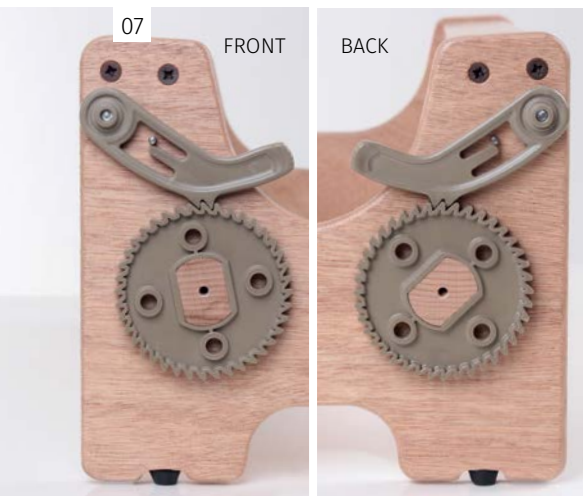

07 Locate the cogs onto the ends of the rollers. Check the teeth engage with the pawl. Then secure with the large washers and 25mm (1") screws.

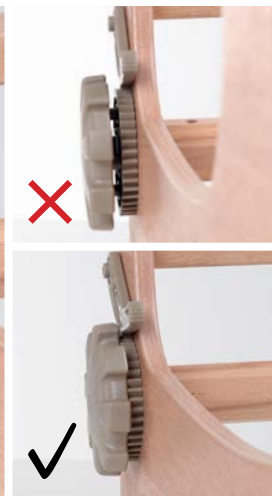
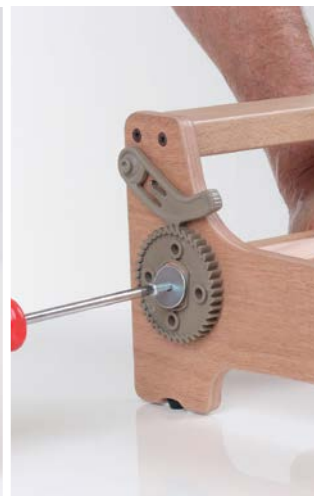

08 Rub a little candle wax on the 4 pegs on one handle. Locate the 4 pegs into the holes in the cog. Firmly hit the handle with your fist or mallet until it locks down tightly onto the cog. There shouldn't be any gap between the handle and cog. Repeat for the other handle.

09



Thread the 15mm ($\frac{5}{8}$ ") screws into the pilot holes in the heddle frame ends using a hand-held screwdriver. Leave a 5mm ($\frac{3}{16}$ ") gap to loop the Texsolv cord over. **Note:** do not use an electric screwdriver as it may drive the screws in too far and crack the heddle frame ends.

10



Insert 2 stainless steel bars into one end of the heddle frame. Slide 2 bundles of Texsolv heddles over the bars. Check the bundles of Texsolv heddles aren't twisted.

11



Locate the other heddle frame end into place. Only then should you remove the twist ties. If desirable cut the Texsolv heddles to separate them. Lay each shaft on a flat surface and check the 2 ends are parallel. Repeat for the other 3 shafts. Locate the 4 shafts with the screws to the top between the loom sides allowing them to sit on your table or assembly bench.

12



Rest the castle front on the edge of your table or assembly bench for support. From the back, locate 4 nylon guides into the holes and tap them home.



13

Locate 8 nylon guides into the holes in the castle top and tap them home.

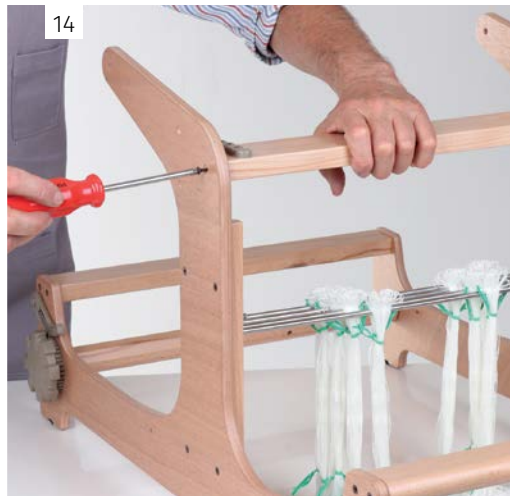

14

Locate the castle top between the sides and secure with 32mm (1¼") screws through the sides.
NOTE: The pilot holes for the castle front face forward.

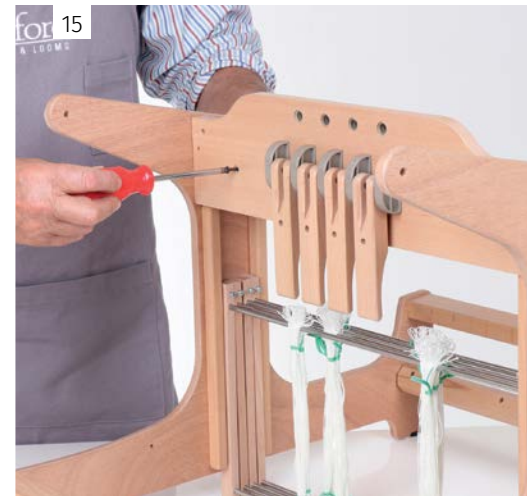

15

Align the pilot holes in the castle top with the holes in the loom sides and castle front and secure with 32mm (1¼") screws through the loom sides and castle front.



16

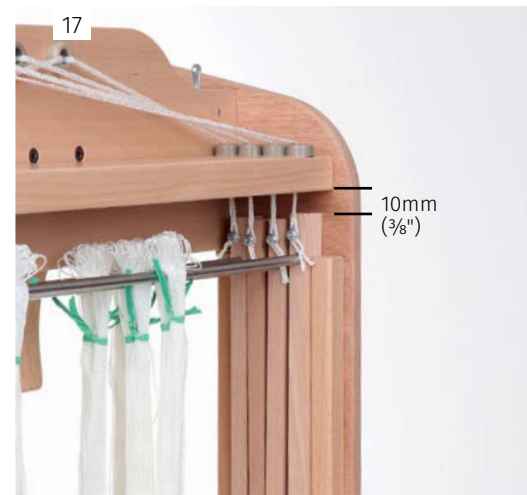

17

Thread both ends of a piece of Texsolv cord down through the front nylon guide on each side of the castle top and loop over the screws on the heddle frame ends of the front shaft. Use the threading hook to pull the cord through the left-hand hole in the castle front, through lever 1 and loop it over the lever as shown. Repeat for the other 3 shafts.

With the levers in the down position adjust the Texsolv cord on both sides of the shaft so there is approx. 10mm (3/8") gap under the castle top on both sides. Once the shafts are even you can trim the cord leaving at least 3 slots from the screw head for further adjustment.

18



Locate the 2 split pins into the holes in either side of the castle front. These pins are used to lock the beater in place when threading the reed.

19



Attach rubber feet to the bottom of both beater sides with 12mm (1/2") screws.

20



Attach both beater sides to the bottom beater rail with 38mm (1 1/2") screws.
NOTE: The groove for the reed faces forward.

21



Attach the top beater rail to the beater sides with 32mm (1 1/4") bolts and barrel nuts.

22



Slide the stainless-steel reed into the slots in the top and bottom beater rails and centre the reed. Twist the top rail down firmly onto the reed and tighten the bolts with the hex wrench supplied.

23



Position 32mm (1¼") bolts halfway through the holes in both loom sides and locate a 16mm (⅝") washer on both bolts. Locate the beater between the loom sides and push both bolts through the holes in the beater sides. Secure with 16mm (⅝") washers and nylock nuts using the hex wrench and spanner supplied. Do not over tighten as the beater must swing freely.

24



To change or reposition the reed, loosen both bolts securing the top beater rail and twist the rail up. Twist the beater rail down and retighten the bolts to secure the reed.

Store the hex wrench in the hole in the castle front.

Tie a knot in one end of the bungee cord. Thread it through the hole in the beater side, through the hole in the castle front and tie a knot in the end. Repeat for the other side. Adjust the position of the knot behind the castle front to increase or reduce the tension until the rubber feet just touch the shaft guides.

Both rubber feet on the beater should touch the shaft guides evenly. If not slightly loosen the screws and bolts, push the beater firmly against the shaft guides and retighten.

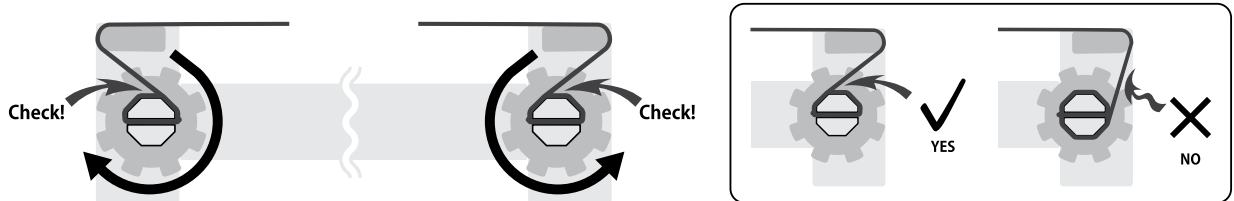
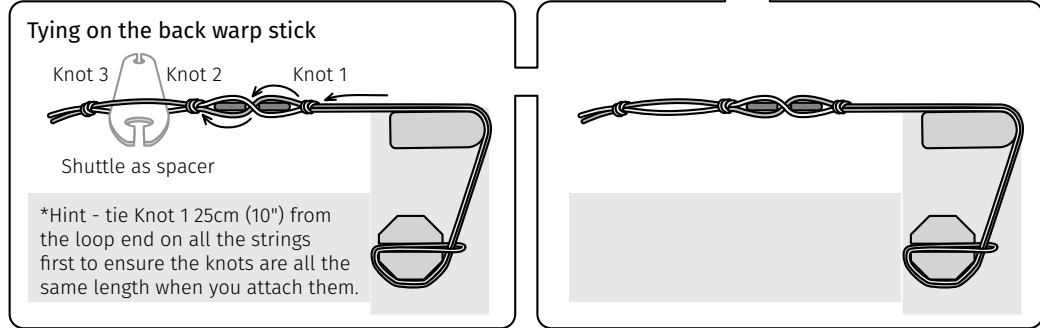
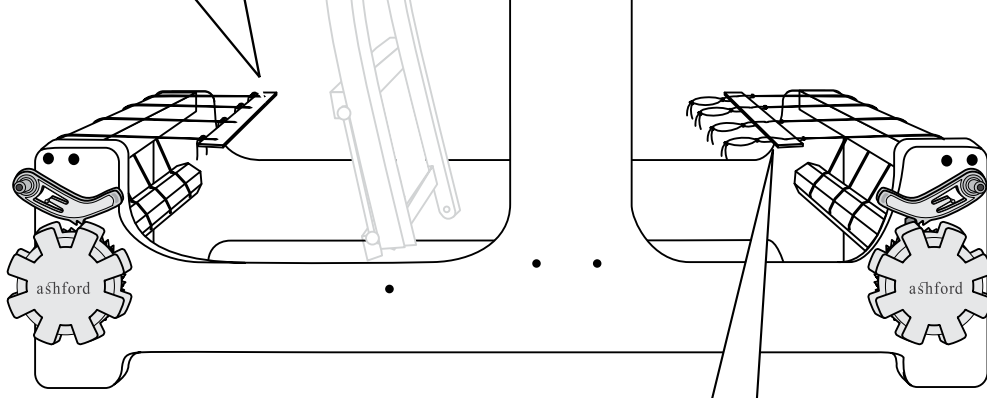
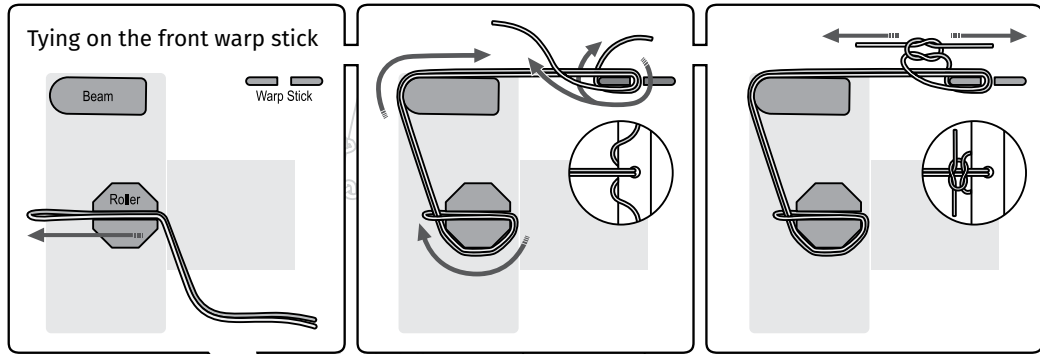

*Hint - To release the warp tension to advance the warp, turn the handle slightly and then lift the pawls on both ends out of the teeth. Your loom is now assembled and ready to be warped.

GLOSSARY

Before you begin your first project on the table loom, here is a glossary of weaving terms you will need to know to get started.

Beaming	Winding the warp under tension onto the back roller.	Shafts (Harnesses)	Frames which hold the heddles. Shaft one is the shaft closest (front) to the weaver.
Beater	Frame holding the reed. Beats the weft thread into place.	Shed	Opening formed in the warp to allow the shuttle to pass.
Cross Sticks	Sticks used to keep the warp threads in the correct order while warping the loom.	Shuttle	Holds the weft yarn.
Dent	Space in the reed.	Sleying	Threading the warp ends through the reed.
Dpi	Dents per inch in the reed.	Threading Cross	Made while winding the warp. Keeps the warp ends in the correct order for threading.
Draft	Instructions for threading and weaving.	Warp	The lengthwise threads held under tension on the loom between the front and back roller.
Drawdown	Diagram of woven cloth resulting from the weaving draft.	Warping Frame	Wooden frame with pegs set in at regular intervals. Used for preparing the warp yarn.
Draw-in	Amount the fabric narrows while weaving.	Warping the Loom	The process of transferring the warp threads to the loom.
End	One warp thread.	Weft	Passes over and under the warp threads to form the woven fabric.
Epi	Ends per inch in the sett.		
Heddle	Holder of a warp thread. One warp thread is threaded in a heddle.		
Loom Waste	Length of warp that cannot be woven at the beginning and end of weaving.		
Pick	Single weft row.		
Raddle	Used to evenly spread the warp threads to the desired weaving width before beaming the warp.		
Raddle Cross	Made at 1/2" (13mm) intervals for counting the warp threads while winding the warp.		
Reed	Frame holding thin metal strips set evenly apart called dents. Used to spread the warp to the desired weaving width.		
Sett	The number of warp threads for each inch of weaving. A balanced plain weave (also called tabby) has the same number of warp and weft threads for each square of weaving. To find the sett, wind the warp and weft around a ruler or yarn gauge for 1" (25mm).		

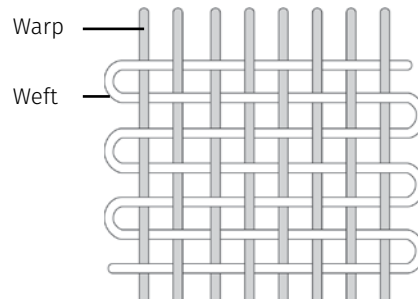

READING THE DRAFT FOR THE DISH TOWELS

Pattern drafts are made of four parts:

1. Threading Draft

This shows the order in which the warp is threaded through the heddle eyes. Threading drafts are read from right to left. For this project, the first warp thread will be threaded through the heddle on shaft one. Two pattern repeats are shown. The bracket above shows how many times to repeat each section.

2. Shafts

Show which shaft to use when threading and lifting.

3. Liftings

This is the order the shafts will be lifted for each weft pick. For this project the first shafts lifted are one and three by pushing levers one and three down.

4. Drawdown

The diagram of the woven cloth produced by the threading and shaft liftings.

1. Threading Draft

x16															
4			4			4			4			4			4
	3			3			3			3			3		
		2			2			2			2			2	
			1			1			1			1			1

2. Shafts

1 2 3 4

1 2 3 4

1 2 3 4

1 2 3 4

1 2 3 4

1 2 3 4

1 2 3 4

1 2 3 4

1 2 3 4

1 2 3 4

1 2 3 4

1 2 3 4

1 2 3 4

1 2 3 4

1 2 3 4

1 2 3 4

1 2 3 4

1 2 3 4

1 2 3 4

1 2 3 4

1 2 3 4

1 2 3 4

1 2 3 4

1 2 3 4

1 2 3 4

1 2 3 4

1 2 3 4

1 2 3 4

1 2 3 4

1 2 3 4

1 2 3 4

1 2 3 4

1 2 3 4

1 2 3 4

1 2 3 4

1 2 3 4

1 2 3 4

1 2 3 4

1 2 3 4

1 2 3 4

1 2 3 4

1 2 3 4

1 2 3 4

1 2 3 4

1 2 3 4

1 2 3 4

1 2 3 4

1 2 3 4

1 2 3 4

1 2 3 4

1 2 3 4

1 2 3 4

1 2 3 4

1 2 3 4

1 2 3 4

1 2 3 4

1 2 3 4

1 2 3 4

1 2 3 4

1 2 3 4

1 2 3 4

1 2 3 4

1 2 3 4

1 2 3 4

1 2 3 4

1 2 3 4

1 2 3 4

1 2 3 4

1 2 3 4

4. Drawdown

3. Liftings

YOUR FIRST PROJECT – 2 DISH TOWELS

You will need:

Loom – Four shaft loom 16" (40cm) or wider

Reed – 10 dpi (10 ends per 2.5cm)

Warping frame, Tape measure, Warp sticks, Cross sticks, Raddle kit, Threading hook, Reed hook, String, Scrap yarn, Shuttles, Scissors

Warp yarn - Ashford Mercerised 5/2 Cotton, Bleached White

Weft yarn – Ashford Mercerised 5/2 Cotton, Grey Pearl, Lilac, Tulip, Turquoise Green (ne 5/2, 848m/927yds, 200gm cone)

Here's how:

Sett – 20 ends per inch (8 ends per cm)

No. of ends: 320

Warp length: 2.2yds (2m)

Width in reed: 16" (40cm)

Dish Towel finished size (hemmed and washed): 2 x 14½ x 24" (37 x 61cm)

Weave Structure: Twill

WINDING THE WARP

Using a warping frame, wind the warp threads.

Remember: Each trip from the start peg to the end peg and back again will be two warp ends.

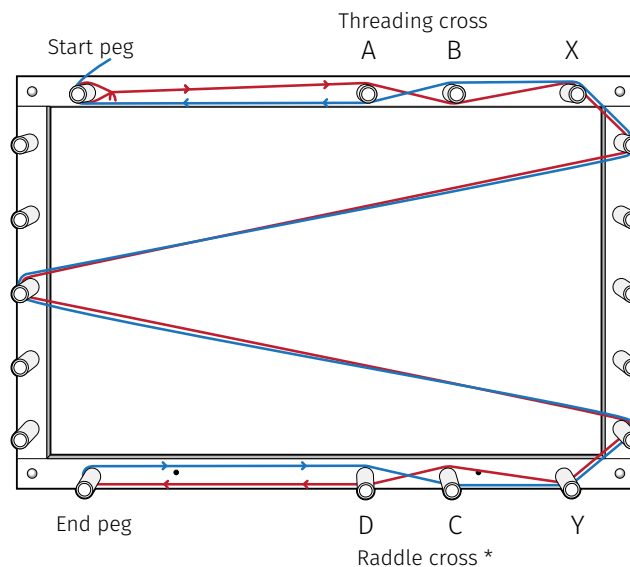

* The raddle cross will be made after each group of 10 threads.

CROSSES

For fuss-free warping, you will make two crosses.



The first cross, between pegs A and B, is the threading cross which keeps the yarn in the correct order for threading. Each thread is separated at the cross.



The second cross between pegs C and D is the raddle or counting cross. As the Ashford raddle has $\frac{1}{2}$ " (13mm) spacings and this project has a sett of 20 dpi we will make the raddle cross after each group of 10 threads.

01

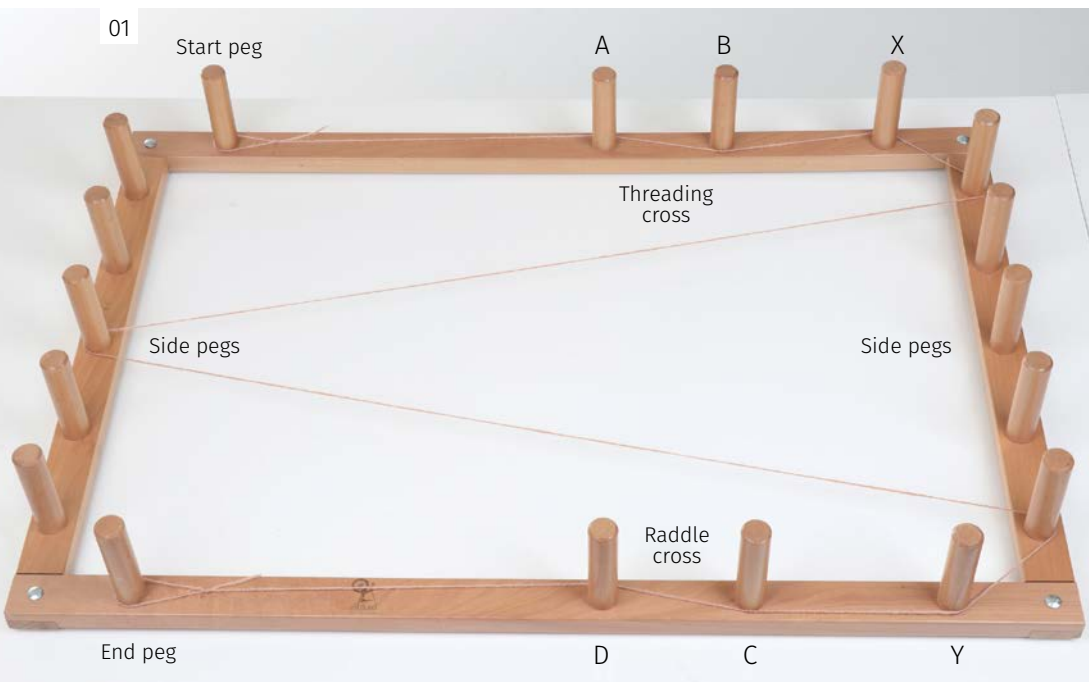

WINDING THE WARP

Measure a length of string the required length of the warp. Tie it to the start peg, take it over peg A, under peg B, over peg X. Go back and forth across the side pegs to accommodate the length of the warp. Finish by going around peg Y, under C, over D and tie to the end peg. This is your warping guide. Note: All threads must pass around collection pegs X and Y and enough middle pegs to reach the required warp length.

See video tutorial on
Winding a warp
<https://youtu.be/JsLHfw6dNWo>

02

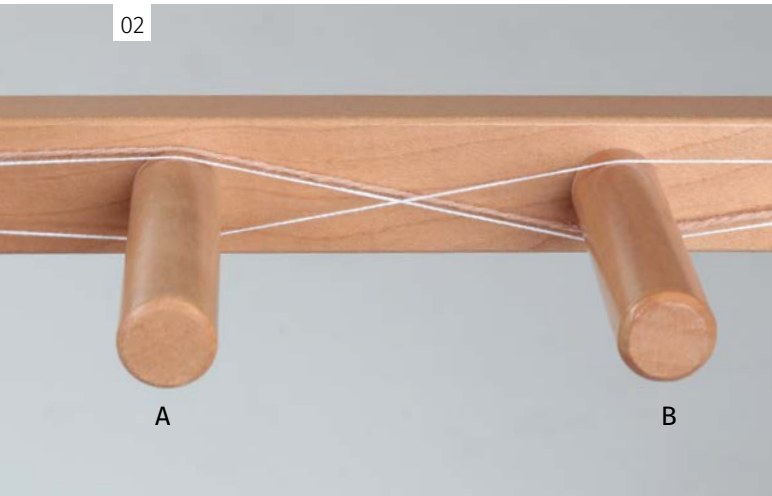

Place the yarn at your feet and begin winding your warp. Remembering to take the yarn over A and under B (when returning pass the yarn over B and under A). This makes the threading cross. Continue around X and the side pegs, down and around Y.

03

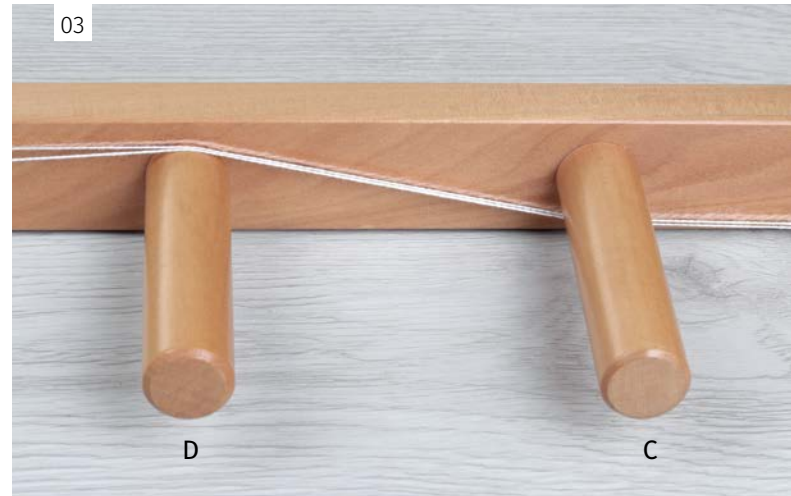

Take the yarn under C, over D and around the end peg. As the raddle cross is in groups of 10, return over D and under C for 10 threads (5 return trips). The eleventh thread will go over C, under D, around the end peg, back under D and over C.

04

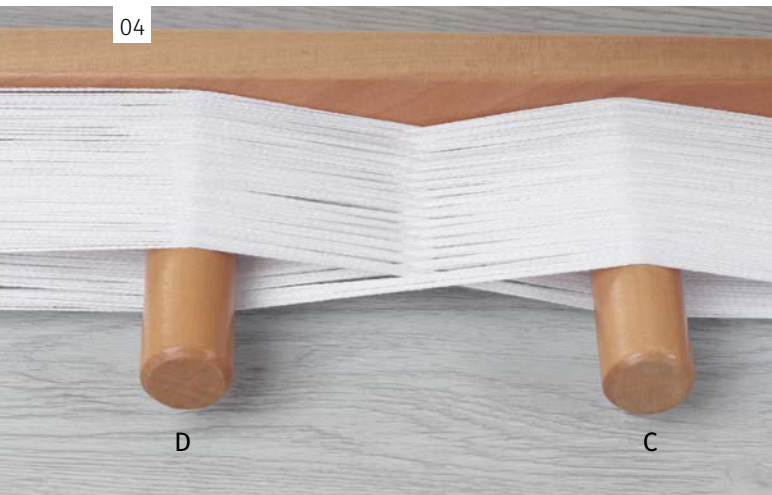

RADDLE CROSS

As you wind, it is very important to keep an even tension on your yarn. After each group of ten ends make a cross between pegs D and C.

05



Push the warp to the base of the pegs from time to time. If the yarn needs to be joined or you are starting a new colour, always tie on at the start peg.

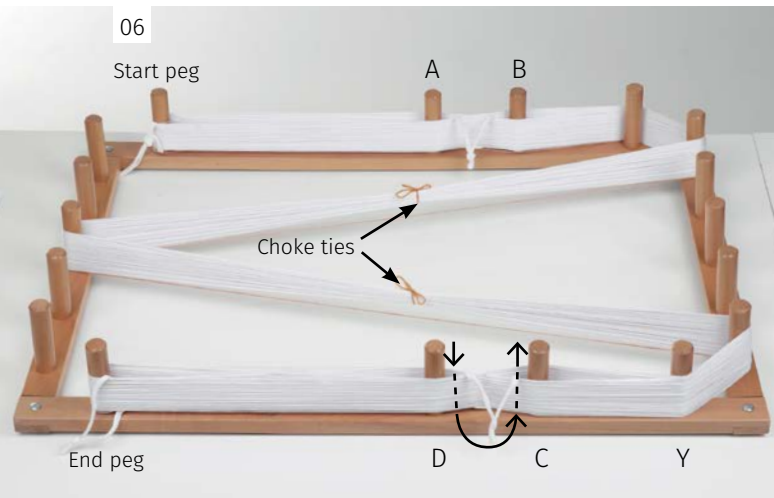

When the warp is finished, knot the last end to the start peg. Secure the warp by loosely knotting scrap yarn through the middle of the threads at the start peg, the threading cross at pegs A and B, the raddle cross C and D and the end peg. For longer warps also place choke ties (tightly) at intervals along the warp.



To remove the warp begin at the start peg. Take your hand through the loop and reach for the warp pulling it back through the loop. Put your hand through the new loop and continue chaining until you reach peg Y.



NOTE: For wider warps wind your warp in two or three separate warps. Winding off and chaining each one.



Before you take your warp to the loom you need to prepare the raddle. The raddle will keep the threads spaced correctly as you wind your warp on the loom.

10

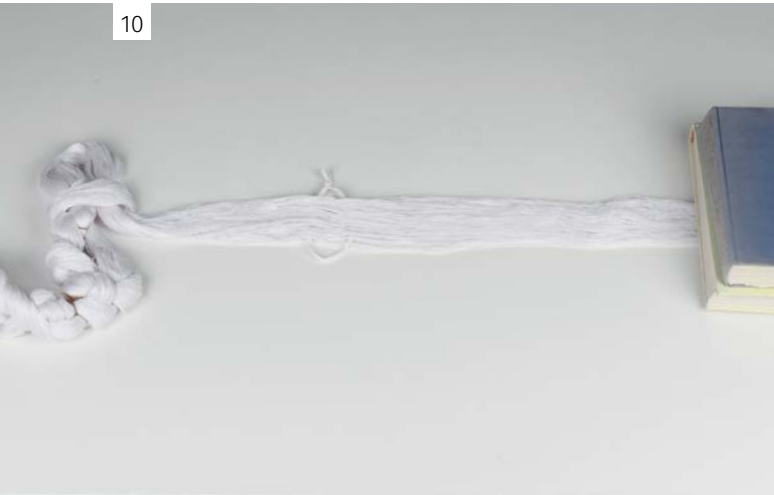

WARPING THE LOOM

Place a heavy object on the end of the warp, or ask a friend to hold.



See video tutorial on How to put a warp on your table loom: Part 1 <https://youtu.be/MVjOF4cfc-Y>, Part 2 <https://youtu.be/BN81LAN9hqc>

11

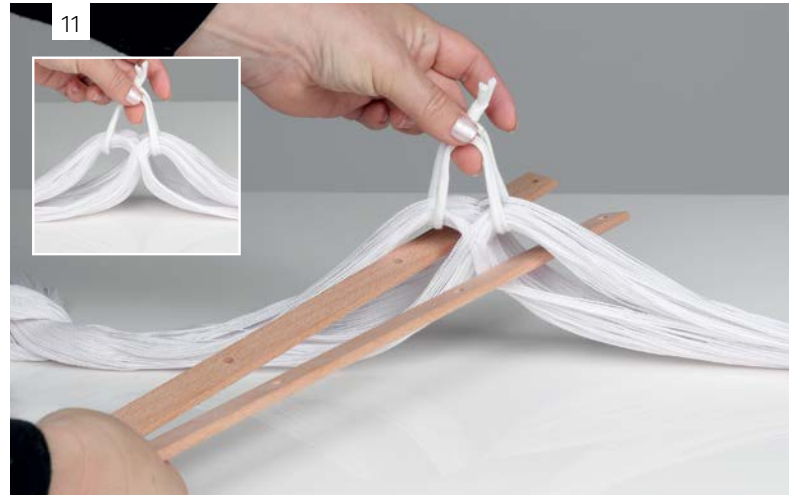

Insert one cross stick through each side of the raddle cross.

12

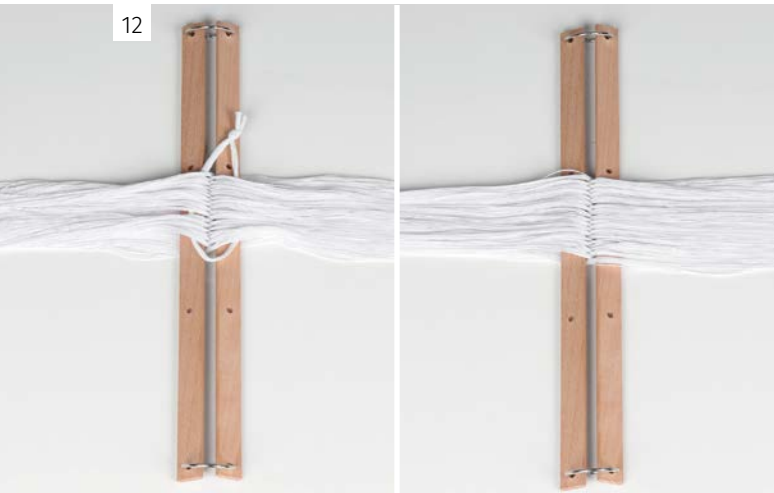

Secure the two sticks with the metal rings included in the raddle kit. Remove the cross tie.

13



Holding the warp up with the cross sticks place the raddle on the table underneath the raddle cross. Remove the ring from one end of the cross stick. Slide each group of threads off the cross stick and onto the raddle.



14

The raddle used has 32 spaces, and as we have 32 groups we are starting at the end space.

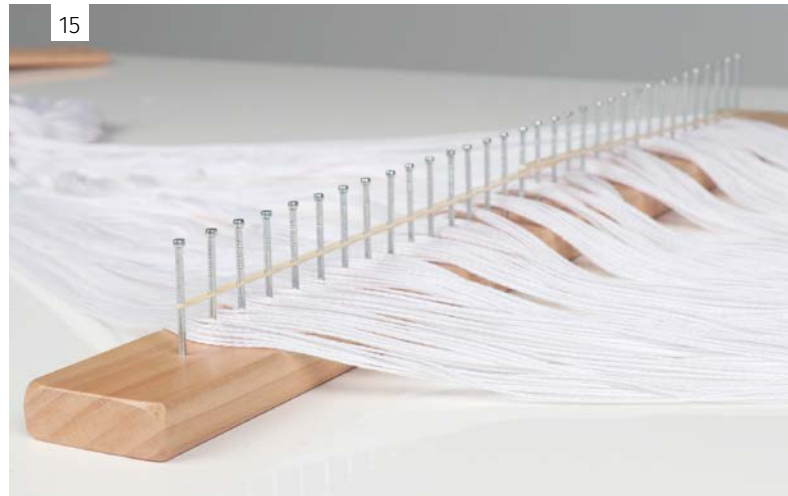

15

If your project is narrower, count the spaces from the centre pin to ensure the warp is evenly placed on the raddle. The centre pin is marked. Secure the warp with rubber bands.



16

Take the raddle with warp to the loom and secure the raddle to the back beam as shown. Take the beginning of the warp through the castle and let it hang over the front beam.

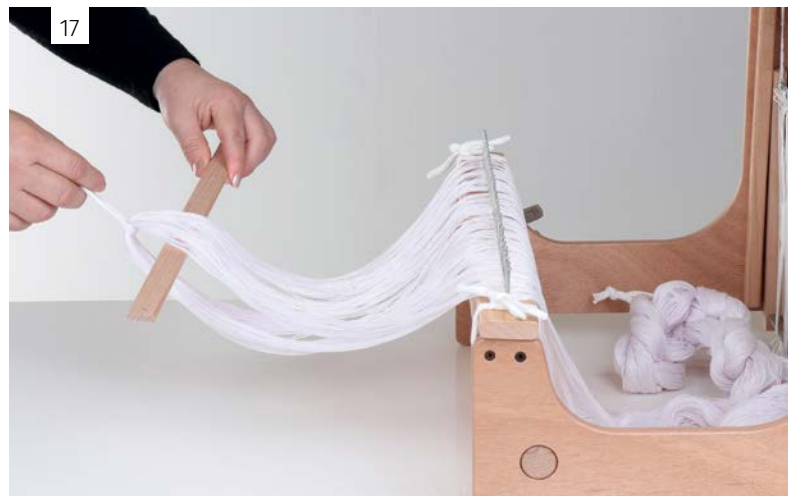

17

Place the warp end stick through the end of the warp. Remove the tie.



18 Slide warp end stick into loops on back warp stick of loom (refer to the assembly instructions for how to attach back warp stick). Secure each end with a rubber band.

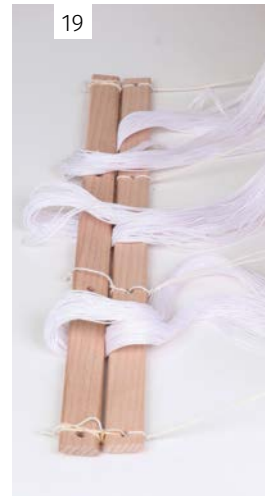

19 Spread the warp out to the same width as the threads in the raddle. Remove the reed.



20 BEAMING THE WARP

Ensure the rear pawl is in the ratchet. Holding the warp under tension with one hand, wind on until the end stick has wrapped around the back roller. Check that the ties securing the raddle are not caught around the roller.



21 CHECK THE DIRECTION YOU ARE ROLLING THE WARP ON. IT MUST GO IN THE DIRECTION SHOWN BY THE ARROWS.

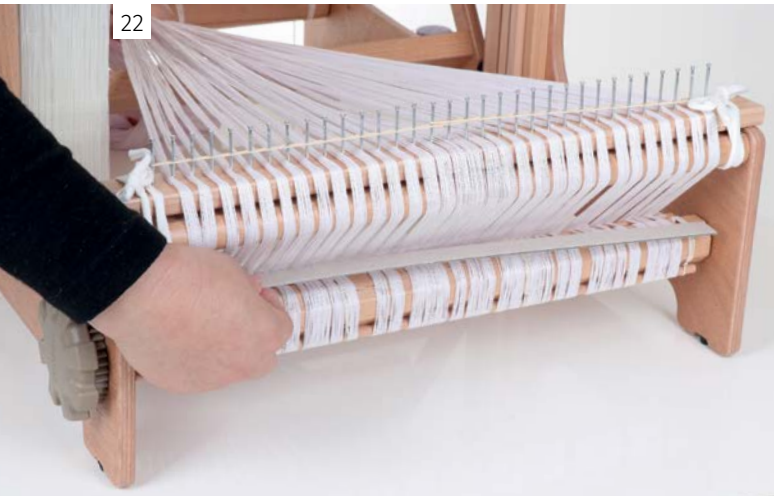

22

Place a cardboard warp stick across the roller.



23

Continue beaming, inserting a cardboard warp stick at each revolution of the roller to separate the warp layers and allow the warp to beam even and smoothly.



24

Wind on until the threading cross arrives behind the castle.



25

To remove the raddle, hold the warp up slightly, remove the rubber bands and the ties.



26 Drop the raddle down from the warp.



27 Attach 'helping hands' (stretchy cords included in the raddle kit) to the loom. On each side go from the front beam, through the castle, around the back beam, back through the castle and tie at the front beam (see A).



28 Place the cross sticks into the cross.



29 To support the cross sticks, use the helping hands, crossed in a figure eight.



30 Secure both ends of the cross sticks with the metal rings.



31 Remove the threading cross tie.



32 THREADING THE LOOM

Before you begin, always check how many heddles are required on each shaft as some drafts may require more heddles on one shaft than on the others. This project requires 80 heddles on each shaft.



33 Take the warp through the castle to the left of the heddles. Tie the warp threads with a piece of scrap yarn using a lark's head knot. Secure the scrap yarn to the front beam. Remove the tie from the end of the warp and cut the loops.



To remove the top beater rail with the hex wrench, loosen the bolts slightly and twist the beater rail up so the barrel nuts do not fall out, then remove.



Following the weaving draft from right to left. Take the first thread on the right of the warp, using the heddle hook, pull it through the eye in the first heddle on the far right of shaft one (front).



Take the next thread through the eye in the first heddle on the far right of shaft two. Continue working from right to left, taking one thread through the eye in the heddle on shafts three and four. Continue until all the threads are through the eyes of the heddles.



Check each 1/2" (13mm) group as it is threaded.

NOTE: It is better to check as you go than to get the full width threaded and then find a mistake.



38

Tie that group in an over hand loop knot in front of the heddles. When all threaded remove the cross sticks and helping hands.



39

SLEYING THE REED

Replace the reed and top rail onto the beater. Hold the beater in place with the cotter pins.



40

For this project, the sett is 20 epi and there are 10 dents per inch (dpi) in the reed, therefore two ends are placed in each dent. Our project is the full width of the loom, start on the far right slot of the reed. If your project is narrower, take the threads through the slot in line with the outside thread of the warp on the back beam, or measure the width from centre of the reed.



41

Once sleyed, tie 1/2" (13mm) groups with a secure knot close to the end.



TYING ON TO THE FRONT OF THE LOOM - Bring the front warp stick up and over the front beam. Place the pawl in the cog. Take a piece of cotton string, approximately 10 times the width of the warp, take it around the front warp stick in line with the right-hand side of the warp. You now have a double thread to “leash” your warp to the front warp stick. Take the ends of the string through the centre of the first group of threads, around the front stick, through the centre of the second group of threads and around the front stick. Continue across the warp, pulling the leashing string firmly as you go. When you reach the left hand side, wind the string around the warp stick and secure with a larks head knot, do 3 of these knots. See video tutorial on Table Loom Warping Part 2 <https://youtu.be/BN81LAN9hc>



Check that the tension is even across the warp, adjusting the leashing as necessary. Using scrap yarn, weave a heading of plain weave to spread the warp evenly.
NOTE: If the weaving is not straight you can adjust the tension by pulling on the string you leashed it on with.



Spread your warp using some scrap yarn. See video tutorial on Spreading the warp <https://youtu.be/A-SW47MtrsQ>.
Plain weave: raise shafts one and three, weave one pick. Lower shafts one and three. Raise shafts two and four. Weave one pick. Beat firmly. Continue until warp threads are spread evenly.

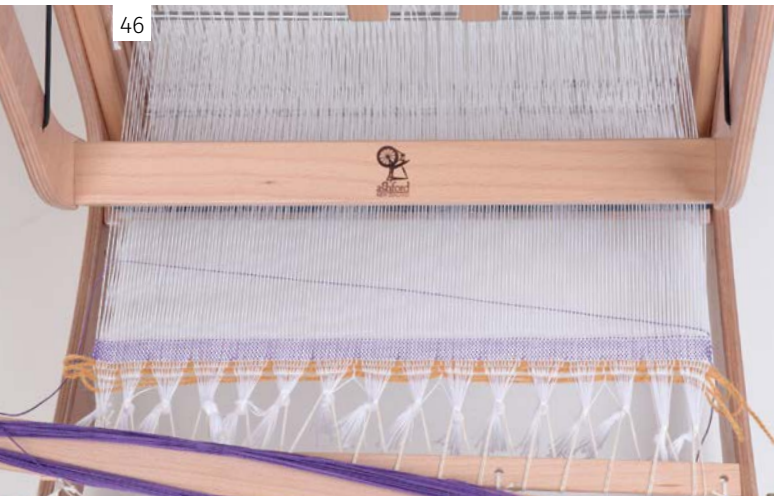

WEAVING

Wind a shuttle with 5/2 Cotton. Begin weaving the dish towel following the lifting sequence in the weaving draft. Weave the hem in plain weave. Raise shafts one and three and enter the shuttle from right to left. Leaving the weft yarn at a 30° angle and 1" (2.5cm) of weft yarn hanging out at the beginning of the pick. Lower all shafts. Raise shafts two and four. Beat weft into place with reed. Tuck the tail end of the thread from the first row into this row. Pass the shuttle from left to right. Lower shaft two and four. Raise shafts one and three. Beat. Continue with this sequence for 1" (2.5cm). This is the hem. Now weave the pattern. Raise shafts one and two, weave one pick. Lower these shafts and raise shafts two and three, beat previous weft into place, then weave one pick, continue as per pattern. When you reach the last row on the draft begin at the first row of the pattern again. Weave a total of 25½" (65cm) following the pattern. Weave 1" (2.5cm) in plain weave for the hem. This is one dish towel woven. Raise shafts one and three, place a cardboard warp stick in the shed, lower one and three. Raise shafts two and four, place another cardboard warp stick. This is your spacer between the dish towels. Begin weaving again. Weave hem, then pattern, then hem.



As the weaving progresses you will have to advance the warp. With all shafts lowered (neutral) release the pawl from the back cog and wind the warp forward by turning the front handle until the last pick is about 2" (5cm) from the front beam. Tighten the tension. As you roll the weaving around you will need to place a strip of cardboard in to cover the knots so they will not poke up through your weaving causing bumps that may affect the tension.

48



49



When the weaving is finished cut from the loom. Remove the heading yarn and using a sewing machine, or by hand, hem under ½" (13mm) at the ends of each towel. Wash in warm soapy water, rinse, dry lying flat and press while still slightly damp.



Off the loom



Washed fabric

FINISHING

When weaving is removed from the loom and before it is washed, darn in all the loose ends. All weaving should be washed so the threads open up and fill the spaces, changing the interwoven threads into fabric.

HELPFUL HINTS

Tying Knots

When you tie any knot during weaving you may need to undo it again at some stage. Always tie a knot that you can undo easily.

Beating

Always beat gently. Sometimes the work will look a little open. Remember, the work is under tension on the loom and will come together when taken off. Also, the washing process will close the gaps a little.

FIXING A BROKEN WARP THREAD

Take a piece of the yarn you used for the warp, make it the same length as your warp. From the back of the loom, thread the yarn through the heddle eye and reed dent (where the broken thread was). Attach it to the weaving in a figure eight around a pin placed approximately 1" (2.5cm) from the edge of the weaving. Hang the end of the yarn over the back beam with a small weight. Resume weaving.
* Remove pin before the weaving is wound around the front beam, otherwise it will catch on subsequent layers.
Carefully trim end near cloth when fabric removed from loom.

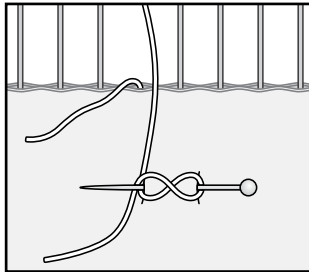

ASSEMBLY CHECK

Check there is a 0.5mm (1/32") gap between the screw that attaches the pawl and the wood.



Check your handles are attached correctly.

TENSION

*The key to successful weaving is to wind the warp on the back roller with an even tension. This takes practice.

*Be kind to yourself, your threads and your loom.

*Be sure each side is rolling on with the same tension.

*Place cardboard sticks between each layer as the warp is rolled on. This prevents the threads pulling through the previous layer.

*Check both selvages roll on with even tension.

*At first it is useful to have the assistance of a friend.

*When you are on your own take the warp in one hand, put the index finger through and down the centre to divide the warp, use the second finger and thumb to spread the warp away from centre and hold the warp under fourth and fifth fingers, then bring the warp down on the front beam to tension. Wind on with the other hand. This technique is suitable for looms no wider than 60cm (24").

*Tie or leash to front stick. With the back of your hand check for even tension across the warp. Adjust if necessary.

* If the warp is correctly wound on the loom, little tension is necessary. If excessive loom tension is required to even the warp tension we recommend you unwind the warp, feeding it back through the reed and wind on again, following the advice above. When wound correctly the warp tension is even and light.



LOOMS AND ACCESSORIES

In addition to the Brooklyn Four Shaft Loom we make a range of folding table looms. The four shaft loom has a 60cm (24") weaving width and the eight shaft looms are available in 40, 60 or 80cm (16, 24 or 32") weaving widths. The compact eight shaft Katie Loom has a 30cm (12") weaving width. There is also a sixteen shaft table loom with a 60cm (24") weaving width.

Recommended Accessories

Warping Frame – holds 11m (37ft) of warp.
Includes clamps.

Warping Frame Small – holds 4.5m (14½ft) of warp.
Lacquered. Perfect companion for the Katie Loom.

Warping Mill – holds 15m (50ft) of warp.

Raddle Kit – for even warp distribution with ½" spacing,
30, 40, 60 or 80cm (12, 16, 24 or 32") wide.

Other Accessories

Boat Shuttles and Bobbins.

Bobbin Winders.

Yarn Stand – holds six cones. Smooth yarn guides ensure snag-free warping. Rubber feet for stability. Lacquered.

Hobby Bench – seven height positions, tilt option for comfortable weaving and roomy storage compartment.

Fringe Twister - for quick and easy finishing of ends.

Pick Up Sticks and Shuttles – in various sizes.

Warp Thread Weights – to weigh floating selvedges, supplementary or broken warp threads.

Reeds - stainless steel reeds for different setts or yarns: 6, 8, 10, 12 and 16dpi.



Warping Frame



Warping Mill

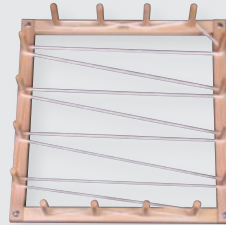

Warping Frame Small



Boat Shuttles and Bobbins



Raddle Kit



Yarn Stand

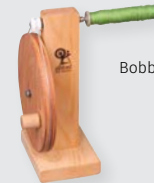

Bobbin Winders



Fringe Twister



Hobby Bench



Warp Thread Weights



Pick Up Sticks (8 sizes)

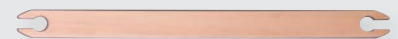

Shuttles (7 sizes)



Wavy Shuttles (3 sizes)

RESOURCES

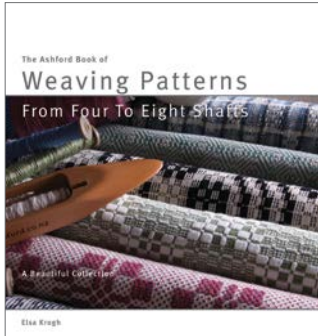

Ashford Book of Weaving Patterns From Four to Eight Shafts

By Elsa Krogh

All of Elsa's favourite patterns - a mixture of classic weaves and modern techniques - for fashion and homeware. 92 pages



The Wheel Magazine

Ashford's annual fibrecraft magazine. Spinning, weaving, felting, dyeing and knitting projects, patterns and articles from around the world. To receive the premium version delivered to you, subscribe at: www.ashford.co.nz/subscribe

Youtube tutorials



Winding a warp



Table loom warping Part 1



Table loom warping Part 2



Tying a warp on a Rigid Heddle Loom



Spreading a warp on a Rigid Heddle Loom



Weaving on the Jack Loom



Using the Fringe twister



Join us on Instagram
[@ashford_wheels_looms](https://www.instagram.com/ashford_wheels_looms)



Join us on facebook
[ashford.wheels.looms](https://www.facebook.com/ashford.wheels.looms)

www.youtube.com/user/AshfordHandicrafts/videos

COTTON

Our four weaving cotton ranges are all available in 18 beautiful modern colours. Suitable for all your weaving projects.



Mercerised 5/2

100% cotton

NE 5/2, 848m/927yds, 200gm

Mercerised 10/2

100% cotton

NE 10/2, 1696m/1854yds, 200gm

Unmercerised 5/2

100% cotton

NE 5/2, 848m/927yds, 200gm

Yoga yarn

82% cotton, 18% nylon core

NE 8/2, 1260m/1386yds, 200gm



CATERPILLAR COTTON

100% cotton variegated dyed yarn with a beautiful crimp, spiral plied texture.

A light weight cotton - perfect for weaving, knitting and crochet.

NE 2/lace weight, 680m/743yds, 200gm cone. *407 Natural White not pictured.



JACK LOOM

When you are ready to expand as a weaver - choose the loom that will suit your needs now and in the future.

The Ashford Jack Loom, with 8 shafts and 10 treadles is a versatile, compact and strong floor loom. Perfect for weaving a wide range of patterns, widths and yarns.

Includes stainless steel reed 12dpi (48/10), 800 texsolv heddles, threading hooks, boat shuttle, cross sticks, wooden warp sticks, pre-cut tie-up cords. Lacquered. Extra reeds 6, 8, 10, 12, 16dpi.

Weaving width 97cm (38")
Weight 58kg (128lb)



Built-in shuttle race

Large rising shed

Easy action warp advancement with steel ratchet

Folding back beam

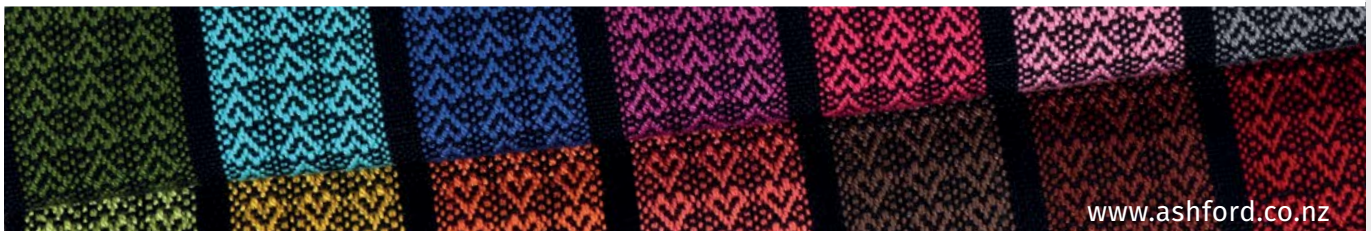
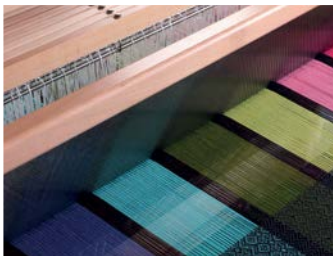

For more information, helpful hints and inspiration we recommend The Ashford Book of Weaving Patterns from Four to Eight Shafts. Visit our website to view our tutorial videos www.ashford.co.nz

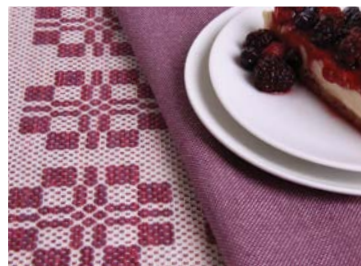
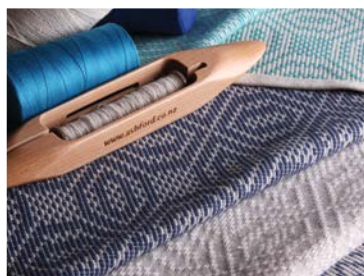

LTWBL V1 2023

Ashford Handicrafts Limited
415 West Street, PO Box 474, Ashburton, New Zealand
Ph +64 3 308 9087 sales@ashford.co.nz www.ashford.co.nz

ashford
WHEELS & LOOMS